

April 2023

## Description

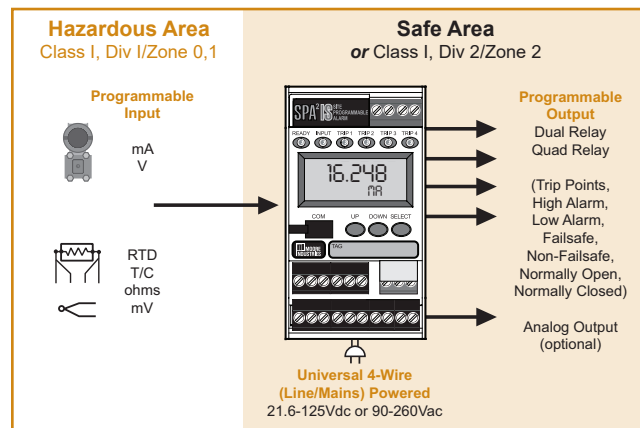
The universal SPA<sup>2</sup>IS Programmable Limit Alarm Trips provide on/off control, warn of unwanted process conditions, alarm on rate-of-change and provide emergency shutdown. Very versatile, they accept signal inputs from transmitters and temperature sensors that are located in hazardous areas where the method of protection implemented by the plant or facility is Intrinsic Safety (Figure 1). Normally such installations would require the additional use of an intrinsically-safe barrier. The SPA<sup>2</sup>IS, however, includes intrinsically-safe field connections which provide the necessary protection typically afforded by a galvanically isolated intrinsically-safe barrier. The SPA<sup>2</sup>IS accepts a wide array of inputs:

- **Current and Voltage Signals**
- **23 RTD Types**
- **9 Thermocouple Types**
- **Resistance and Potentiometer Devices**
- **Direct Millivolt Sources**

### Dual and Quad Alarm Trip Outputs

The 4-wire (line/mains-powered) SPA<sup>2</sup>IS provides two or four independent and individually-configurable alarm relay outputs when a monitored process variable falls outside of user-set high and/or low limits. This is typically used to activate a warning light, annunciator, bell, pump, motor or shutdown system.

**Figure 1.** Available SPA<sup>2</sup>IS models deliver versatile and programmable input and output choices.



### Certifications



**IECEx**



The SPA<sup>2</sup>IS features a metal, RFI resistant housing with display that snaps onto standard DIN-style rails.

## Features

- **Intrinsically-Safe Field Connections.** Apply inputs from temperature sensors or transmitters located in hazardous areas without the need of a costly intrinsically-safe barrier. Plus power an intrinsically-safe loop using the 2-wire transmitter excitation in the current/voltage input model.
- **Universal plant standard.** With programmable input/output parameters, and “Universal” DC or AC power input, there’s no need to stock dozens of different alarm trips.
- **20-bit input resolution.** Delivers industry-best digital accuracy for both sensor (RTD and thermocouple) and analog (current/voltage) inputs.
- **Site- and PC-Programmable.** Featuring security password protection, the SPA<sup>2</sup>IS offers the choice of using front panel pushbuttons or our FREE Windows®-based Intelligent PC Configuration Software for fast and simple setup.
- **Large 5-digit process and status readout.** A backlit display shows menu prompts during pushbutton configuration and, when the SPA<sup>2</sup>IS is in operation, shows the process variable, the output or toggles between the two in selectable engineering units.
- **Combined alarm trip and transmitter.** The analog output (-AO) option reduces costs and installation time when both alarm and transmitter functions are needed at the same location.
- **Long-term stability.** Provides up to 5 years between scheduled calibrations.
- **Isolated and RFI/EMI protection.** Delivers superior protection against the effects of ground loops and plant noise.

# SPA<sup>2</sup>IS

## Programmable Limit Alarm Trips with Intrinsically-Safe Field Connections

### SPA<sup>2</sup>IS Associated Apparatus

An IS system installation requires a barrier or associated apparatus interface between the field device and the control room equipment (Figure 2). Its function is to limit the energy to the hazardous area such that, even under a fault condition, there cannot be enough electrical or thermal energy released by the device to ignite an explosive atmosphere.

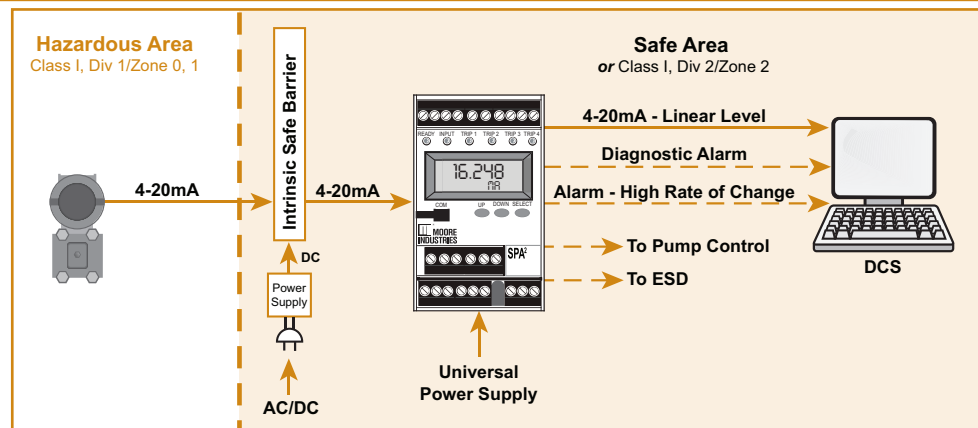
Zener Diode barriers are simple passive devices comprised of zener diodes, resistors and fuses that serve to limit the voltage, current, and power available to the hazardous area device. A common downside of using this approach is that the required earth ground has low noise rejection capability. This electrical interference can introduce stray and unwanted electrical noise components into the measurement circuit creating potentially significant measurement errors.

Isolated barriers are active devices that incorporate galvanic isolation thus eliminating the requirement for an earth ground. These barriers require auxiliary operating power and cost more than passive zener barriers.

The disadvantage of these separate IS barriers is the installation and maintenance costs. Many of these costs can be drastically reduced if an associated apparatus like the SPA<sup>2</sup>IS is used. Since the associated apparatus includes the barrier in the receiving device there is no need for the additional cost of the barrier, cabinet space, a high integrity clean ground connection, separate power supply or custom vendor backplane.

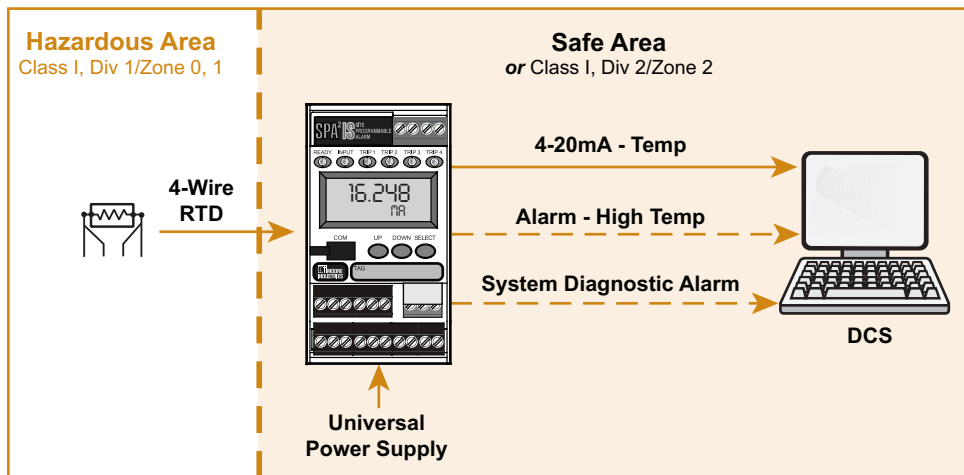
**Associated apparatus** incorporate a barrier into the safe area (Class I, Div 2/Zone 2 or Unclassified) mounted receiving device or the control room equipment. The Moore Industries SPA<sup>2</sup>IS is an example of such a device that provides an isolating barrier within the alarm trip (Figure 3 and 4). This dramatically reduces the cost of purchase, installation and maintenance versus more traditional approaches that require a separate zener or isolating barrier.

**Figure 2.** An intrinsically-safe system utilizing isolated barriers.

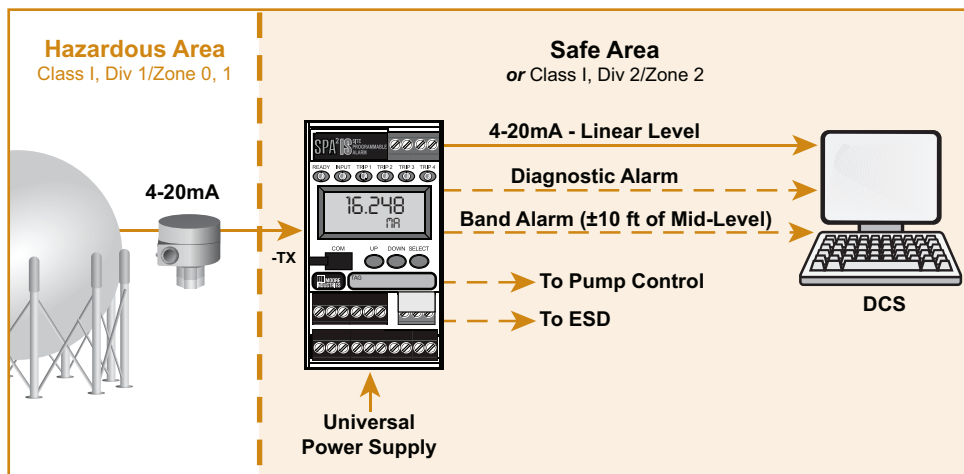


Because the SPA<sup>2</sup>IS offers the dual role of transmitter/isolated barrier combination in one package this provides significant cost savings by reducing the number of components, power supply requirements, cabinet space, wiring terminations, installation labor

and stocking requirements. Furthermore, these savings are ongoing with reduced spares inventory, maintenance-related downtime and consequent process restart issues.



**Figure 3.** A Moore Industries SPA<sup>2</sup>IS associated apparatus incorporating IS barrier, temperature transmitter, temperature alarm and diagnostic alarming functions in a single device.



**Figure 4.** A Moore Industries SPA<sup>2</sup>IS Associated Apparatus incorporating an IS barrier, spherical tank linearization measurement function, local pump control, Hi-Hi ESD, local indication, self-diagnostics, and quad relay outputs for control and alarming.

See the white paper: **“Associated Apparatus: The Safe and Most Affordable IS Solution”** for a more detailed overview of Associated IS Apparatus.

# SPA<sup>2</sup>IS

Programmable Limit Alarm Trips with Intrinsically-Safe Field Connections

## Site- and PC-Programmable

Operating parameters configure quickly and easily using front panel pushbuttons or our Intelligent PC Configuration Software. Programmable functions include:

- Security password protection on/off and password
- Input type and measurement range (zero and full scale values)
- Input and output trimming
- Multiple alarm options including high or low trip, out of band, rate of change, stuck input and fault alarm
- Failsafe or non-failsafe, and normally open or normally closed alarm relays
- Alarm deadband (0-100%) and alarm time delay
- T/C reference junction compensation (on/off)
- Display parameters (scale, engineering units, and set number of digits after the decimal point)
- Differential or averaging of RTD inputs
- Standard and custom linearization curves (up to 128 points)\*
- Analog output range\*\*
- On input failure, upscale or downscale drive, fail to last value or fail to selected value\*\*
- Analog signal output damping (0-30 seconds)\*\*

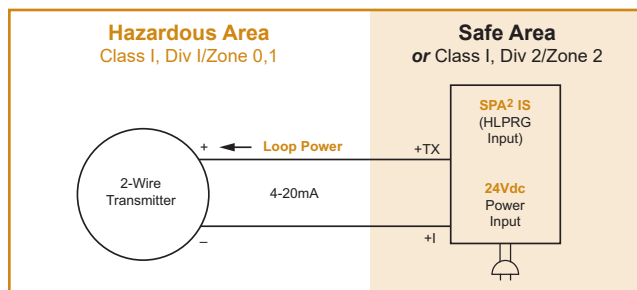
\*Programmable via the PC Configuration Software only.

\*\*Models with Analog Output (+AO) option.

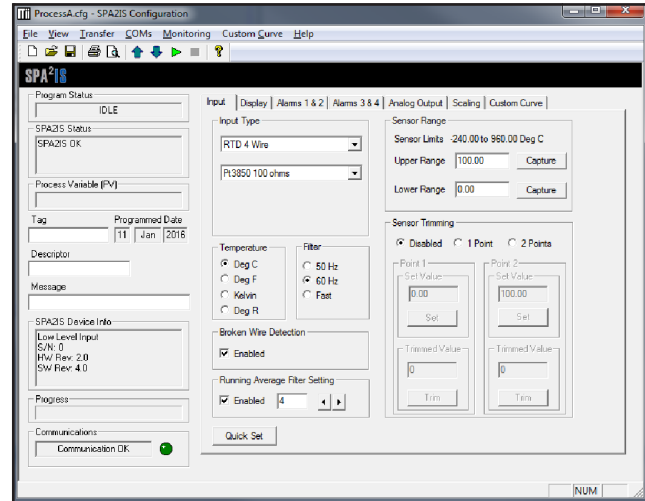
## Powers a 2-Wire Transmitter

The SPA<sup>2</sup>IS (HLPRG: current/voltage input model) comes standard with 2-wire transmitter excitation that provides 24Vdc to power the loop. This saves the cost of specifying and installing an additional instrument power supply to power a 2-wire transmitter on the input loop.

**Figure 5.** The SPA<sup>2</sup>IS provides transmitter excitation to power a 2-wire transmitter.



**Figure 6.** In addition to pushbutton configuration, the SPA<sup>2</sup>IS programs quickly from a single software window.



## Versatile Alarm Options

Each individually-configurable SPA<sup>2</sup>IS alarm trip relay programs via the PC software as a:

**Band Alarm**—Combines the High and the Low Trip Alarms into one. It can be used to warn of a process that has left its normal operating conditions.

**Stuck Alarm**—Monitors the input with respect to time and trips when that input hasn't changed by a user-selected rate (Delta) over a user selected time period (Delta Time).

**High or Low Limit Process Alarm**—Monitor a temperature, pressure, level, flow, position or status variable, and use to warn of unwanted process conditions (Figure 4), provide emergency shutdown or provide on/off control (Figure 5).

**Rate-of-Change Alarm**—Monitor an input for a change in value with respect to time (Figure 6). The alarm trips when the input rate-of-change exceeds a user-selected rate (Delta) over a user selected time period (Delta Time).

**Input Fault Alarm**—Setting one of the alarm's relays to trip on input or self-diagnostic failure (without affecting the other relay being used to monitor the process) is typically implemented to warn of a failure, such as a broken sensor, without tripping more critical process alarms or shutting down the process.

**Out of Range Alarm**—Monitor your process variable (PV). If the value strays past user-set limits, the SPA<sup>2</sup>IS will go into an alarm state indicating that the PV has gone out of the allowed range.

**Self-Diagnostic Alarm**—The SPA<sup>2</sup>IS checks its own operation and configuration upon start up, and then continuously monitors its status during operation. One of the SPA<sup>2</sup>IS relays can be configured to trip if it senses that it is not operating properly.

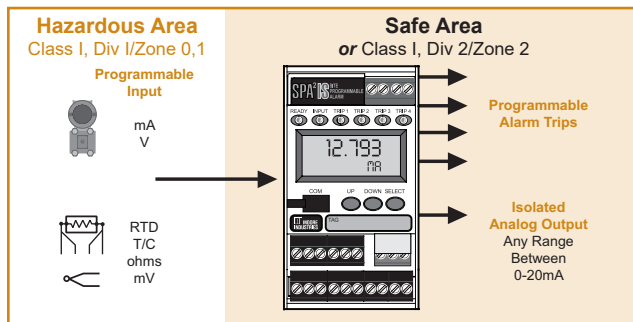
### Quick Ranging Calibration

Using the front panel pushbuttons or the PC Configuration Software (instead of potentiometers which can drift), precise zero and span settings can be made in seconds. Just select the zero and span values, and the push of a button locks the values into the alarm trip's memory.

### Combination Alarm and Isolated Transmitter

When ordered with the Analog Output (-AO) option, the SPA<sup>2</sup>IS provides a proportional and isolated analog retransmission of the input signal that can be sent to remote monitoring/control devices like a DCS, PLC, PC, indicator or data recorder (Figure 7). All analog parameters can be selected using the SPA<sup>2</sup>IS push buttons or the Intelligent PC Configuration Software. Upon input failure, the analog output can be user-set for upscale or downscale drive or fail to last value.

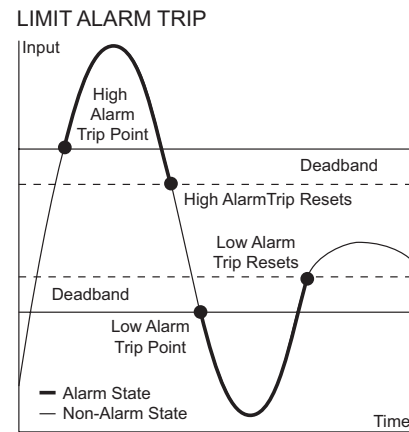
**Figure 10.** When ordered with the Analog Output (-AO) option, the SPA<sup>2</sup>IS is a combination alarm trip and signal transmitter.



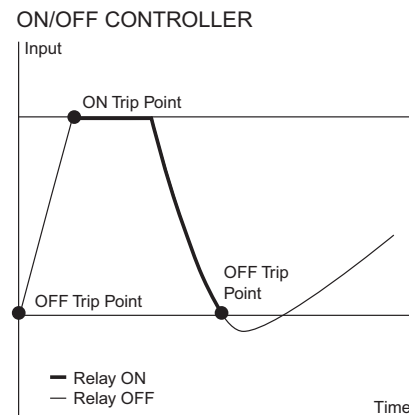
### Continuous Self-Diagnostics

Incorporating advanced self-diagnostics, the SPA<sup>2</sup>IS checks its own operation and configuration upon start up and then continuously monitors its status during operation. If it senses that it is not operating properly, it displays an error message on its display indicating what condition has occurred. In addition, one or more of the alarm trip outputs can be set as a fault alarm which will trip when an unwanted diagnostic condition occurs.

**Figure 7.** High and/or low limit alarms, with a selectable deadband to reduce false alarms, can be used to warn of unwanted process conditions or to provide emergency shutdown.

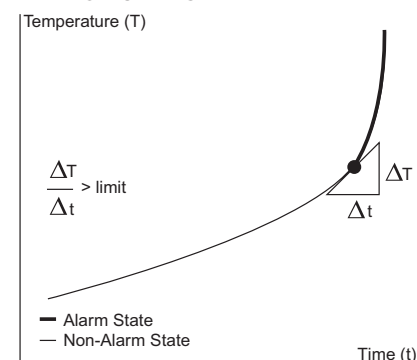


**Figure 8.** The SPA<sup>2</sup>IS can be used as a simple on/off controller such as those required in level applications (pump/valve control) when filling or emptying a container or tank.



**Figure 9.** The SPA<sup>2</sup>IS can be set to trip when the input rate-of-change exceeds a user-selected rate (Delta) over a user-selected time period (Delta Time).

### RATE-OF-CHANGE ALARM



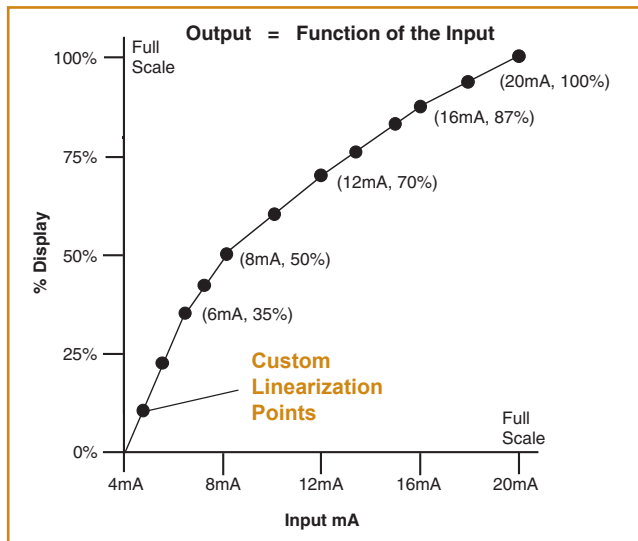
# SPA<sup>2</sup>IS

Programmable Limit Alarm Trips with Intrinsically-Safe Field Connections

## Custom 128-Point Linearization Curves

The ability to plot a custom linearization curve is beneficial when non-linear input signals must be converted to linear output representations (Figure 11). Typical applications include monitoring a non-linear transducer, the level of odd-shaped tanks and flow meter linearization.

**Figure 11.** Using the Intelligent PC Configuration Software, up to 128 custom linearization points can be selected and saved in the SPA<sup>2</sup>IS's memory to compensate for non-linear input signals.



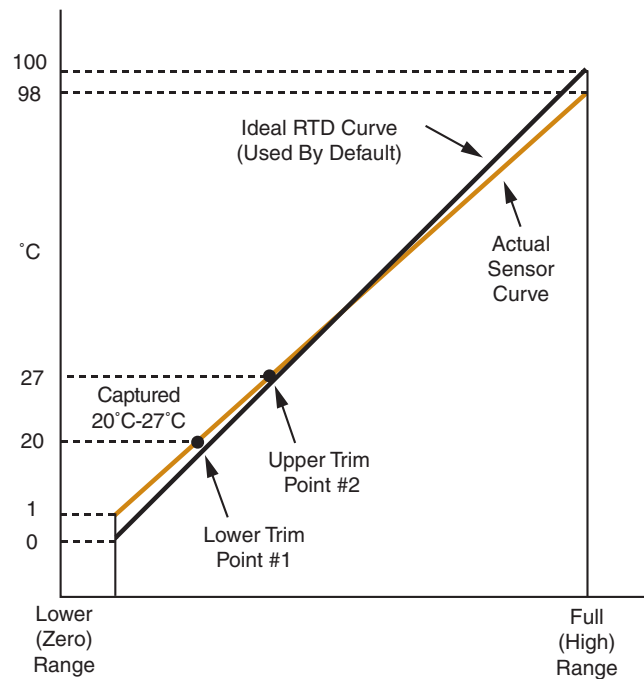
## Total Sensor Diagnostics for RTD Inputs

Our SPA<sup>2</sup>IS Programmable Limit Alarm Trip (TPRG input model) performs continuous sensor diagnostics (Figure 13). This industry-first and patented Moore Industries feature saves you time and money by letting you know when a problem occurs, and its type and location. If the RTD input breaks, the user can decide whether or not to trip one or more alarms to indicate trouble. A plain-English error message on the display, as well as on the PC Configuration Software, indicates exactly which RTD wire has broken. Specific error messages eliminate the work of removing the sensor or checking all lead wires to diagnose a problem. If equipped with the Analog Output (-AO) option, the user has the option of driving the analog output either upscale or downscale on sensor failure.

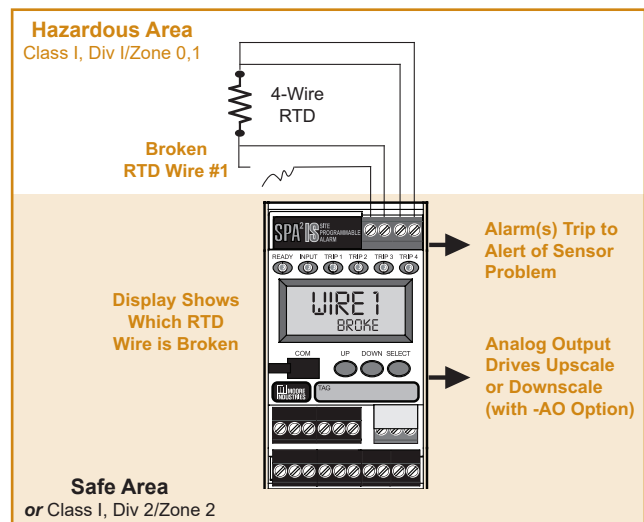
## Trim to Specific Curve Segments

The SPA<sup>2</sup>IS can be trimmed with two data points within the selected zero and span measurement range (Figure 12). This allows a complete process range to be monitored while placing measurement emphasis on a critical segment of the range. This provides incredible precision over a limited portion of the span while measuring the remainder of the span with outstanding accuracy.

**Figure 12.** The SPA<sup>2</sup>IS can be set to measure the segment most critical to the process.



**Figure 13.** Patented "Total Sensor Diagnostics" saves troubleshooting time by identifying which sensor wire has broken.



### Specifications (HLPRG: mA and V Input Model)

**Performance** **Input Range:** Current Input 0-50mA (1mA minimum span); Voltage Input 0-11V (250mV minimum)

**Input Accuracy and Alarm Trip Repeatability:** Current inputs,  $\pm 2$  microamps (0.01% of 20mA span); Voltage inputs,  $\pm 1$ mV (0.01% of max. span)

**Overall Accuracy:** The overall accuracy of the unit is the combined input and output accuracies. It includes the combined effects of linearity, hysteresis, repeatability and adjustment resolution. It does not include ambient temperature effect.

**Stability:** Refer to Table 1

**Dead Band:** 11.5V or 50mA, maximum in Linear Mode; equivalent of maximum input range in user-set engineering units in Scaling/Custom Mode

**Response Time:** 256msec typical (Defined as the time from step change on input to alarm state change when alarm is set to trip mid-point)

**Alarm Trip Delay:** Programmable from 0-120 seconds

**Power Supply Effect:**  $\pm 0.002\%$  of span for a 1% change in line voltage (AC or DC)

**Isolation:** 500Vrms between case, input, output (units with -AO option) and power, continuous.

**Dielectric Strength:** Will withstand 1560Vrms for 2 seconds between input, output and power; 500Vrms for 2 seconds from case to input, output or power

**Power Supply:** Universal 21.6-125Vdc or 90-260Vac;

**Power Consumption:** 3.5W typical, 5.5W maximum

**Performance (continued)** **Input Impedance:** Current inputs, 20 ohms; Voltage inputs, 1 Mohm

**Input Over-Range Protection:** Voltage inputs,  $\pm 30$ Vdc; Current inputs,  $\pm 100$ mA

**TX Power Supply:** Open Circuit Voltage/Short-Circuit Current: 25.2V/42.5mA, Available Voltage: 17V at 23.6mA  $\pm 10\%$ @24mA (regulated)

**Relay Outputs:** Single-pole/ double-throw (SPDT), 1 form C, rated 5A@250Vac, 50/60Hz or 24Vdc, non-inductive

**Performance WITH ANALOG OUTPUT with Analog Output (-AO Option)** **Output Accuracy:**  $\pm 0.01\%$  of maximum span ( $\pm 2$  microamps)

**Response Time:** 256msec maximum (128msec typical) for the output to change from 10% to 90% of its scale for an input step change of 0 to 100%

**Ripple (up to 120Hz):** Current output, 10mVp-p when measured across a 250 ohm resistor

**Output Limiting:**

Output	Failure Limits
0-20mA	0, 23.6mA
4-20mA	3.6, 23.6mA
X-20mA	(90% of X), 23.6mA
0<X<4	

**Ambient Conditions** **Load Capability:** Source mode (internal power supply), 0-1000 ohms

**Load Effect (current outputs):**  $\pm 0.01\%$  of span from 0 to 1000 ohms

**Operating Range:** -40°C to +85°C (-40°F to +185°F)

**Storage Range:** -40°C to +85°C (-40°F to +185°F)

**Ambient Conditions (continued)** **Ambient Temperature Effect:** 2 microamps/°C  $\pm 0.009\%$  of max. span/°C

**Relative Humidity:** 5-95%, non-condensing

**RFI/EMI Protection:** 80% AM at 1Khz 20V/m @ 20-1000Mhz per IEC61000-4-3.

**Noise Rejection:** Common Mode, 100dB@50/60Hz Normal Mode, Current Input, 70dB typical@50mAp-p@ 50/60Hz; Voltage Input, 70dB typical@1Vp-p@ 50/60Hz

**Adjustments** Front panel pushbuttons parameter configurations; Internal jumper and menu password protect parameter settings

**Indicators** **LCD:** 2x5 14-segment characters, backlight, alphanumeric readout accurate to the nearest digit.

**Range:** -99999 to 99999; Decimal point can be user-set

**LED Type:** INPUT LED: Dual color LED indicates input failure

READY LED: Green LED indicates unit is operating properly

ALARM 1, 2, 3 and 4 LED: Dual color LED per relay indicates alarm status

**Display Accuracy:**  $\pm 1$  digit; when scaling the display (or in Custom Mode), high input-to-display span ratios decrease display accuracy

**Weight** 544 g to 618 g (19.2 oz to 21.8 oz)

Table 1. Long-Term Stability

(% of Maximum Span)	Input-to-Output (Years)			Input-to-Relay (Years)		
	1	3	5	1	3	5
Current Inputs	0.081	0.14	0.18	0.047	0.081	0.105
Voltage Inputs	0.093	0.16	0.21	0.066	0.114	0.147

# SPA<sup>2</sup>IS

Programmable Limit Alarm Trips with  
Intrinsically-Safe Field Connections

## Specifications (TPRG: RTD, T/C, Ohm, mV and Potentiometer Input Model)

<p><b>Performance</b></p> <p><b>Input Accuracy and Alarm Trip Repeatability:</b> Refer to Table 2</p> <p><b>Overall Accuracy:</b> The overall accuracy of the unit is the combined input and output accuracies. It includes the combined effects of linearity, hysteresis, repeatability and adjustment resolution. It does not include ambient temperature effect. For T/C input, add the RJC error.</p> <p><b>Reference Junction Compensation Accuracy (T/C inputs only):</b> ±0.45°C</p> <p><b>Stability:</b> Refer to Table 3</p> <p><b>Dead Band:</b> User set within selected input range; fully scalable and set in user-selected engineering units</p> <p><b>Input to Output Response Time:</b> 256msec typical (Defined as the time from step change on input to alarm state change when alarm is set to trip mid-point)</p> <p><b>Alarm Trip Delay:</b> Programmable from 0-120 seconds</p> <p><b>Power Supply Effect:</b> ±0.002% of span for a 1% change in line voltage (AC or DC)</p> <p><b>Isolation:</b> 500Vrms between case, input, output (units with -AO option) and power, continuous.</p> <p><b>Dielectric Strength:</b> Will withstand 1560Vrms for 2 seconds between input, output and power; 500Vrms for 2 seconds from case to input, output or power.</p> <p><b>Power Supply:</b> Universal 21.6-125Vdc or 90-260Vac</p>	<p><b>Power Consumption:</b> 3W typical, 3.5W maximum</p> <p><b>Input Over-Range Protection:</b> ±5Vdc</p> <p><b>Excitation Current:</b> (RTD and Ohms) 250 microamps, ±10%</p> <p><b>Relay Outputs:</b> Single-pole/double-throw (SPDT), 1 form C, rated 5A@250Vac, 50/60Hz or 24Vdc, non-inductive</p> <p><b>Performance with Analog Output (-AO Option)</b></p> <p><b>WITH ANALOG OUTPUT</b></p> <p><b>Output Accuracy:</b> ±0.01% of maximum span (±2 microamps);</p> <p><b>Response Time:</b> 256msec maximum (128msec typical) for the output to change from 10% to 90% of its scale for an input step change of 0 to 100%</p> <p><b>Ripple (up to 120Hz):</b> Current output, 10mVp-p when measured across a 250ohm resistor</p> <p><b>Output Limiting:</b></p> <table border="1"> <thead> <tr> <th>Output</th> <th>Failure Limits</th> </tr> </thead> <tbody> <tr> <td>0-20mA</td> <td>0, 23.6mA</td> </tr> <tr> <td>4-20mA</td> <td>3.6, 23.6mA</td> </tr> <tr> <td>X-20mA</td> <td>(90% of X), 23.6mA</td> </tr> <tr> <td>0&lt;X&lt;4</td> <td></td> </tr> </tbody> </table> <p><b>Load Capability:</b> Source mode (internal power supply), 0-1000 ohms</p> <p><b>Load Effect (current outputs):</b> ±0.01% of span from 0 to 1000 ohms resistance</p> <p><b>Ambient Conditions</b></p> <p><b>Operating Range:</b> -40°C to +85°C (-40°F to +185°F)</p> <p><b>Storage Range:</b> -40°C to +85°C (-40°F to +185°F)</p>	Output	Failure Limits	0-20mA	0, 23.6mA	4-20mA	3.6, 23.6mA	X-20mA	(90% of X), 23.6mA	0<X<4		<p><b>Ambient Conditions (continued)</b></p> <p><b>Ambient Temperature Effect:</b> Refer to Table 4</p> <p><b>Effect of Ambient Temperature on Reference Junction Compensation (T/C inputs only):</b> ±0.005% per °C change of ambient temperature</p> <p><b>Relative Humidity:</b> 5-95%, non-condensing</p> <p><b>RFI/EMI Protection:</b> 80% AM at 1Khz 20V/m @ 20-1000Mhz per IEC61000-4-3</p> <p><b>Noise Rejection:</b> Common Mode, 100dB@50/60Hz Normal Mode, refer to Table 5</p> <p><b>Adjustments</b></p> <p>Front panel pushbuttons parameter configurations; Internal jumper and menu password protect parameter settings</p> <p><b>Indicators</b></p> <p><b>LCD:</b> 2x5 14-segment characters, backlit, alphanumeric readout accurate to the nearest digit.</p> <p><b>Range:</b> -99999 to 99999; Decimal point can be user-set</p> <p><b>LED Type:</b> INPUT LED: Dual color LED indicates input failure READY LED: Green LED indicates unit is operating properly ALARM 1, 2, 3 and 4 LED: Dual color LED per relay indicates alarm status</p> <p><b>Display Accuracy:</b> ±1 digit; when scaling the display (or in custom mode), high input-to-display span ratios decrease display accuracy</p> <p><b>Weight</b> 544 g to 601 g (19.2 oz to 21.2 oz)</p>
Output	Failure Limits											
0-20mA	0, 23.6mA											
4-20mA	3.6, 23.6mA											
X-20mA	(90% of X), 23.6mA											
0<X<4												

Table 3. Long-Term Stability

(% of Maximum Span)	Input-to-Output (Years)			Input-to-Relay (Years)		
	1	3	5	1	3	5
RTD, Ohm & Pot Inputs	0.09	0.16	0.21	0.047	0.081	0.104
T/C & mV Inputs	0.08	0.14	0.18	0.008	0.014	0.019



**Table 2. Accuracy with RTD, Thermocouple, Ohms, and Millivolt Inputs (Models with TPRG Input)**

Input	Type	$\alpha$	Ohms	Conformance Range	Minimum Span	Input Accuracy/ Repeatability	Maximum Range
RTD (2-, 3-, 4-Wire)  Dual (2-Wire, One 2-Wire and One 3-Wire)	Platinum	0.003850	100	-200 to 850°C (-328 to 1562°F)	10°C (18°F)	±0.1°C (±0.18°F)	-240 to 960°C (-400 to 1760°F)
			200				
			300				
			400				
			500				
			1000				
			Dual 500				
		0.003902	100	-100 to 650°C (-148 to 1202°F)	10°C (18°F)	±0.1°C (±0.18°F)	-150 to 720°C (-238 to 1328°F)
			200				
			400				
			500				
			1000				
			Dual 500				
			Dual 1000				
0.003916	100	-200 to 510°C (-328 to 950°F)	10°C (18°F)	±0.1°C (±0.18°F)	-240 to 580°C (-400 to 1076°F)		
Nickel	0.00672	120	-80 to 320°C (-112 to 608°F)	10°C (18°F)	±0.1°C (±0.18°F)	-100 to 360°C (-148 to 680°F)	
Copper	0.00427	9.035	-50 to 250°C (-58 to 482°F)	10°C (18°F)	±0.85°C (±1.53°F)	-65 to 280°C (-85 to 536°F)	
Ohms	Direct Resistance	n/a	0-4000	0-4000 ohms	10 ohms	±0.4 ohms	0-4095 ohms
			Dual 0-4000 ohms	0-4000 ohms	10 ohms	±0.4 ohms	0-4095 ohms
	Potentiometer	4000 maximum	0-100%	10%	±0.1%	0-100%	
T/C	J	n/a	n/a	-180 to 760°C (-292 to 1400°F)	35°C (63°F)	±0.25°C (±0.45°F)	-210 to 770°C (-346 to 1418°F)
	K	n/a	n/a	-150 to 1370°C (-238 to 2498°F)	40°C (72°F)	±0.3°C (±0.54°F)	-270 to 1390°C (-454 to 2534°F)
	E	n/a	n/a	-170 to 1000°C (-274 to 1832°F)	35°C (63°F)	±0.2°C (±0.36°F)	-270 to 1013°C (-454 to 1855.4°F)
	T	n/a	n/a	-170 to 400°C (-274 to 752°F)	35°C (63°F)	±0.25°C (±0.45°F)	-270 to 407°C (-454 to 764.6°F)
	R	n/a	n/a	0 to 1760°C (32 to 3200°F)	50°C (90°F)	±0.55°C (±0.99°F)	-50 to 1786°C (-58 to 3246.8°F)
	S	n/a	n/a	0 to 1760°C (32 to 3200°F)	50°C (90°F)	±0.55°C (±0.99°F)	-50 to 1786°C (-58 to 3246.8°F)
	B	n/a	n/a	400 to 1820°C (752 to 3308°F)	75°C (135°F)	±0.75°C (±1.35°F)	200 to 1836°C (392 to 3336.8°F)
	N	n/a	n/a	-130 to 1300°C (-202 to 2372°F)	45°C (81°F)	±0.4°C (±0.72°F)	-270 to 1316°C (-454 to 2400.8°F)
	C	n/a	n/a	0 to 2300°C (32 to 4172°F)	100°C (180°F)	±0.8°C (±1.44°F)	0 to 2338°C (32 to 4240.4°F)
mV	DC	n/a	n/a	n/a	4mV	±30 microvolts	-50 to 1000mV

# SPA<sup>2</sup>IS

Programmable Limit Alarm Trips with  
Intrinsically-Safe Field Connections

## Ordering Information

Unit	Input	Output	Power	Options	Housing
<b>SPA<sup>2</sup>IS</b> Programmable Limit Alarm Trip with Associated IS Inputs for Current/Voltage, RTDs and Thermocouples	<b>HLPRG</b> Programs to accept: Current: Any range between 0-50mA including: 0-20mA 4-20mA 10-50mA Voltage: Any range between 0-10Vdc including: 0-5Vdc 1-5Vdc 0-10Vdc <b>TPRG</b> Programs to accept (see Table 2 for details): RTD: 2-, 3- and 4-wire; platinum, copper, and nickel Thermocouple: J, K, E, T, R, S, B, N, C Ohms: 0-4000ohms (Potentiometer, 4000ohms maximum) Millivolts: -50 to +1000mV	<b>2PRG</b> Dual Relays (Relays are single-pole/double-throw (SPDT), 1 form C, rated 5A@250Vac, 50/60Hz or 24Vdc, non-inductive)  <b>4PRG</b> Quad Relays (Relays are single-pole/double-throw (SPDT), 1 form C, rated 5A@250Vac, 50/60Hz or 24Vdc, non-inductive)  Each relay individually configures for: High or Low Trip Normally Open or Normally Closed Failsafe or Non-Failsafe	<b>U</b> Universal accepts any power input range of 21.6-125Vdc or 90-260Vac	<b>-AO</b> Analog output (isolated and linearized) scalable for any range between 0-20mA into 1000 ohms (see "Specifications" for additional information)  <b>-FMEDA</b> Unit comes with Failure Modes, Effects and Diagnostic Analysis (FMEDA) data for evaluating the instrument for suitability of use in a safety-related application	<b>DIN</b> DIN-style housing mounts on 35mm (EN50022) Top Hat DIN-rails  <b>FLB</b> Flange mount bracket for wall mounting

**When ordering, specify:** Unit / Input / Output / Power / Options [Housing]  
**Model number example:** SPA2IS / TPRG / 2PRG / U / - AO [DIN]

**Table 4. Ambient Temperature Effect**

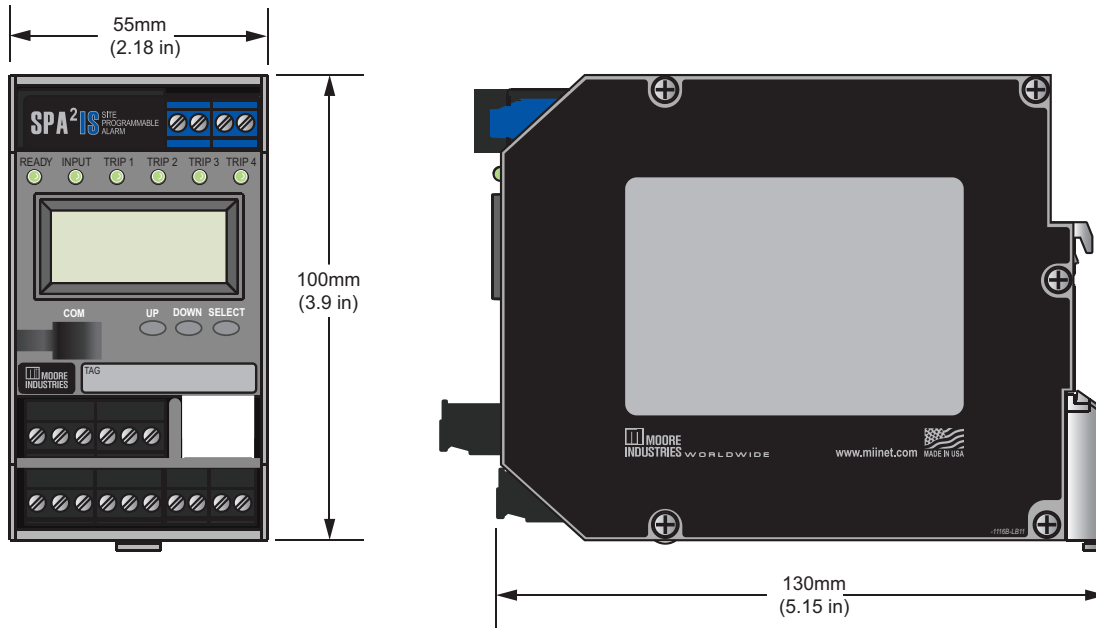
Accuracy per 1°C (1.8°F) Change in Ambient	
RTD*	0.0035°C
Millivolt	0.5 microvolts + 0.005% of reading
Ohm	0.002 ohms + 0.005% of reading
Thermocouple	
Accuracy per 1°C (1.8°F) Change in Ambient	
J	0.00016°C + 0.005% of reading
K	0.0002°C + 0.005% of reading
E	0.00026°C + 0.005% of reading
T	0.0001°C + 0.005% of reading
R, S	0.00075°C + 0.005% of reading
B	0.0038°C + 0.005% of reading
N	0.003°C + 0.005% of reading
C	0.00043°C + 0.005% of reading
mV	0.5 microvolts + 0.005% of reading

\*Accuracy of Ni672 is 0.002°C

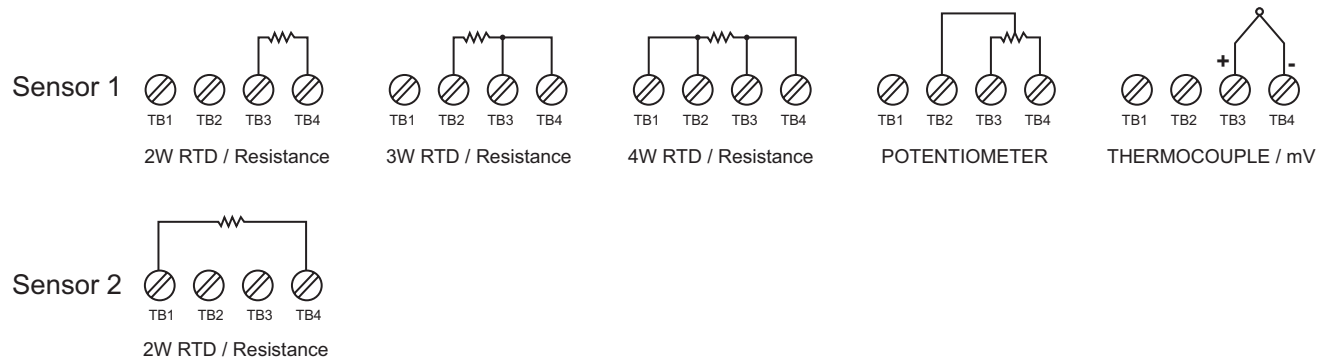
**Table 5. Normal Mode Rejection Ratio**

Sensor Type	Max. p-p Voltage Injection for 100dB at 50/60Hz	
T/C: J, K, E, N, C	150mV	
T/C: T, R, S, B	80mV	
Pt RTD: 100, 200, 300 ohms	250mV	
Pt RTD: 400, 500, 1000 ohms	1V	
Ni: 120 ohms	500mV	
Cu: 9.03 ohms	100mV	
Resistance	mV	
1-4 kohms	250-1000	1V
0.25-1 kohms	62.5-250	250mV
0.125-0.25 kohms	31.25-62.5	100mV

**Figure 14. Installation Dimensions**



**Figure 15. Temperature Sensor Hook-Up Guide (Models with TPRG Input)**



**Note:** When using 2 input sensors, sensor 1 is limited to 2-wire and/or 3-wire RTD/resistance. 4-wire sensors cannot be used.

# SPA<sup>2</sup>IS

Programmable Limit Alarm Trips with  
Intrinsically-Safe Field Connections

**Table 6. Terminal Designations**

Top Terminals (Left to Right)	
Terminal Number	1    2    3    4
TPRG Input	1    2    3    4
HLPGR Input	TX    +I    COM    +V

Center Terminals (Left to Right)									
Terminal Number	5	6	7	8	9	10	11	12	13
Center	NC3	CM3	NO3	NC4	CM4	NO4	AC/DC	AC/DC	GND

Bottom Terminals (Left to Right)										
Terminal Number	14	15	16	17	18	19	20	21	22	23
Bottom	NC1	CM1	NO1	NC2	CM2	NO2	MR	MR	+lo	-lo

**NOTES:**

- Terminal blocks can accommodate 14-22 AWG solid wiring, tighten to four inch-pounds (maximum).
- ±lo labeling is present only when the unit is equipped with the Analog Output (-AO) option.

**KEY:**

AC/DC = Universal Power	+I = Current Input	NC = Normally Closed
CM = Relay Common	lo = Current Output	SPDT = Single-Pole/Double-Throw
GND = Ground (case)	MR = Manual Reset	TX = 2-Wire Transmitter Power
	NO = Normally Open	+V = Voltage Input

## Accessories

Each SPA<sup>2</sup>IS order comes with one copy of our Intelligent PC Configuration Software. Use the chart below to order additional parts.

Part Number <b>225-75D05-02</b>	<b>Intelligent PC Configuration Software</b> (One copy provided free with each order)
Part Number <b>803-053-26</b>	<b>Non-Isolated Serial Communication</b>
Part Number <b>804-030-26</b>	<b>Fuse Protected, Non-Isolated USB Communication Cable</b>

**Certifications**

 **Factory Mutual – FM Approvals – US/Canada (cFMus):**

**Associated Intrinsically-Safe**

Class I, II, III, Division 1, Groups A-G  
[Class I, Zone 0], AEx [ia] IIC, Ex [ia] IIC

**Non-Incendive**

Class I, Division 2, Groups A, B, C & D

**Non-Sparking**

Class I, Zone 2, AEx nA [ia] IIC, Ex nA [ia] IIC



**ATEX Directive 2014/34/EU (FM Approvals):**  
**Associated Intrinsically-Safe & Type “n”**

⊕ II (1) G [Ex ia Ga] IIC  
⊕ II 3 (1) G Ex nA [ia Ga] IIC T4 Gc

**IECEX IECEX (FM Approvals):**

**Associated Intrinsically-Safe & Type “n”**

[Ex ia Ga] IIC  
Ex nA [ia Ga] IIC T4 Gc

**Temperature Code:**

T4 @ 85°C Maximum Operating Ambient



**CE Conformant:**

EMC Directive 2014/30/EU - EN 61326



United States • info@miinet.com  
Tel: (818) 894-7111 • FAX: (818) 891-2816  
Australia • sales@mooreind.com.au  
Tel: (02)8536-7200 • FAX: (02) 9525-7296

*Demand Moore Reliability*

**www.miinet.com**

BeNeLux • info@mooreind.eu  
Tel: 03/448.10.18 • FAX: 03/440.17.97

China • sales@mooreind.sh.cn  
Tel: 86-21-62491499 • FAX: 86-21-62490635  
United Kingdom • sales@mooreind.com  
Tel: 01293 514488 • FAX: 01293 536852